

Non-Invasive Optical Diagnostics of Pigment Formations of Human Skin

V.G. PETRUCK¹, A.P. IVANOV², S.M. KVATERNYUK¹, V.V. BARUN^{2,3}, B.A. BOLYUKH⁴,
D.B. BOLYUKH⁴

¹Vinnica National Technical University, Vinnica, Ukraine

²B.I. Stepanov Institute of Physics, Belarus National Academy of Sciences, Minsk, Belarus

³Belarus State University of Informatics and Radioelectronics, Minsk, Belarus

⁴M. Pirogov Vinnica National Medical University, Vinnica, Ukraine

barun@dragon.bas-net.by

Abstract — Measurement results of spectral reflection characteristics under multiple light scattering by healthy skin and by skin regions with melanoma or nevus are given. Experimental setup that operates on the base of the Taylor method is described. It is shown that the diffuse reflectance R of melanoma skin is lower at all the studied wavelengths from the range about 450 to 1000 nm as compared with that of healthy and benign nevus skin. This conclusion is confirmed by a large number of measurements of big groups of different persons. The gathered data demonstrated an opportunity to differ malignant and healthy or benign formations, while operating in the visible to near IR range. Examples of such a differentiation at several wavelengths are given.

Index Terms — skin, pigment formations, melanoma, nevus, spectral diffuse reflectance, experiments, integrating sphere.

I. INTRODUCTION

The traditional means for non-invasive investigation of human skin melanoma is visual dermatoscopy. One also applies digital devices that enable a magnified tumor image to be get on a computer monitor. However, even by using modern devices equipped by modern optics and digital CCD cameras, the diagnostic methods of oncologic tumors based on dermatoscopic index according to the ABCD rules are generally subjective. Besides, the accuracy of the differentiation of melanomas and nevi is low and depends essentially on the experience of oncologic physicians. This work studies spectral characteristics of light reflection by healthy skin and by pigment formations on skin. A number of wavelengths are established that enable one to propose ways for discriminating melanoma and nevus by measuring light reflection by skin under *in vivo* conditions.

II. EXPERIMENTAL SETUP AND DATA PROCESSING

Before the measurements, a tumor was cleaned and wiped by a napkin impregnated by alcohol. Undamaged skin near the tumor and a control region of intact skin were processed by an antiseptic solution. The measuring device (Fig. 1) consists of a monochromatic light source 1, two photometric sensors (integrating spheres) 2 and 3 having identical parameters. The internal surfaces of the spheres are covered by a standard reflecting matter. Input openings of the sensors 2 and 3 are connected to the source 1 by optical fibers 4 and 5. The input and working openings of each sphere are located on the same axis, and a light receiver 6 (or 7) is set perpendicular to it. There is a quartz lens 8 (or 9) at the input of the sensor, which provides the diameter of the light beam in the working opening. The sensors 2 and 3 are equipped by end caps 10. Their surfaces are covered by the same matter as the spherical cavities 2 and 3. The receivers 6 and 7 are electrically connected to

recording equipment 11. The device contains also micro controllers 12 and 15, personal computer 13 with software 14 for processing the reflection spectra.

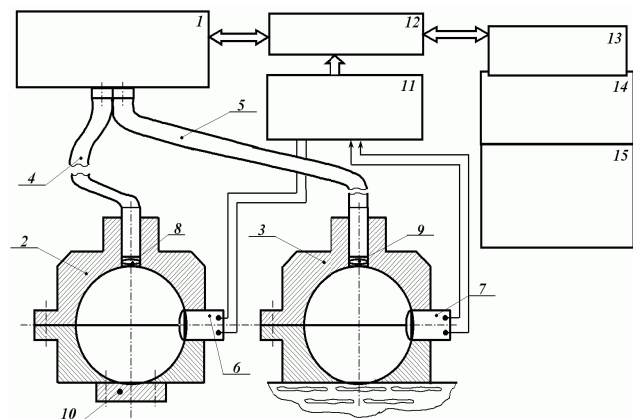

Fig. 1. Scheme of the experimental setup

One of the sensors is applied to tumor, so that its opening is at the center of a pathological region, or to an area of undamaged skin. The diffuse reflectance spectra of pigment formations are processed and compared with normal tissue by dedicated software. The spectra of normal and pathological tissues were studied over the wavelength range of $\lambda = 450 - 1050$ nm provided by the monochromator 1. Experiments were started with the compensation of photodiode dark currents and the normalization of the spectral characteristics of the measuring channels with respect to a standard measuring means. The obtained characteristic enables one to cancel the differences between the spectral sensitivities of the receivers of the two channels. We non-invasively measured the diffuse reflectance spectra of pathological skin with melanoma or with pigment nevus, as well as of normal skin of a healthy person.

The measured spectra were recorded in a databank with the indication of the experiment date, person's surname, age and a pathology type, and a number of additional medical data obtained in the course of other evaluations for comparing them with the spectral results.

A value of skin diffuse reflectance was get by the correction using coefficient k_C that accounts for differences between the spectral sensitivities of the receivers of the two channels, $k_C = k_1/k_2$. Coefficient k_C was determined experimentally with the end caps set at the inputs of each channel. A non-linear regression by a fourth-order polynomial was used further to get the calibration function:

$$k_C(\lambda) = 1.82 \cdot 10^{-4} - 0.00876\lambda + 5.49 \cdot 10^{-4} \lambda^2 - 4.86 \cdot 10^{-7} \lambda^3 + 1.13 \cdot 10^{-10} \lambda^4 \quad (1)$$

Figure 2 shows the calibration plot $K_C(\%) = 100k_C$ for equalizing the spectral sensitivities. The relative changes in the spectra for different tissues were compared by using calibrated values of diffuse reflectance $R(\lambda) = R_1(\lambda)/k(\lambda)$.

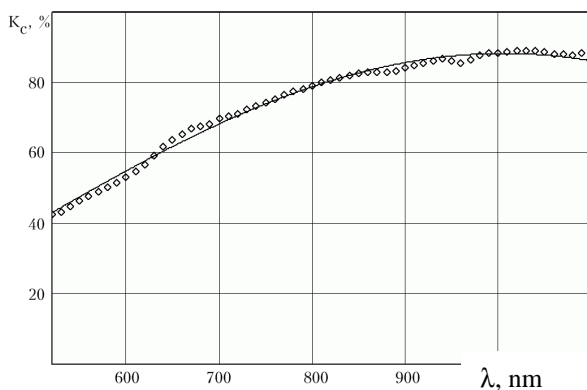

Fig. 2. The calibration plot: $\diamond\diamond$ – experiment, — – approximation with using Eq. (1)

III. THE PERSONS

We investigated spectra healthy tissues of 552 persons, who do not have any pathology of skins, bones, or internal organs. There were among them 237 men (43 %) and 315 women (57 %) of ages 15 to 45 years. The spectra were measure too for 31 patients with melanoma. There were among them 9 men (29 %) and 22 women (71 %) of ages 21 to 89 years. The melanoma diagnosis in different histological forms was confirmed for all the sick patients according to the classification adopted by the World Health Organization. The spectrophotometric studies of nevus were made for 20 patients with suspicion of malignant nevus. Among the investigated persons of this group, there were 8 men (40 %) and 12 women (60 %) of preadult and mature ages. All the nevus carriers were operated, and the diagnosis was confirmed by the histological studies.

IV. REFLECTION CHARACTERISTICS

The normalized spectra of undamaged skin (Fig. 3) were used further for the comparison with the similar data on melanoma and nevus. A respectively large dispersion of the reflectance values in Fig. 3 over the range of approximately $\lambda < 600$ nm and $\lambda > 100$ nm can be explained of varying

blood quantity in tissues of the group of conditionally healthy persons. Besides, the sensitivity of the receiver is lower at $\lambda < 550$ nm to be another reason of experimental errors. Over wavelength range of about 650 to 1000 nm the dispersion of the reflectance values for intact skin is smaller than 5 %. This enables one to use this range for the comparison with the spectral characteristics of other pigment formations (nevus and melanoma).

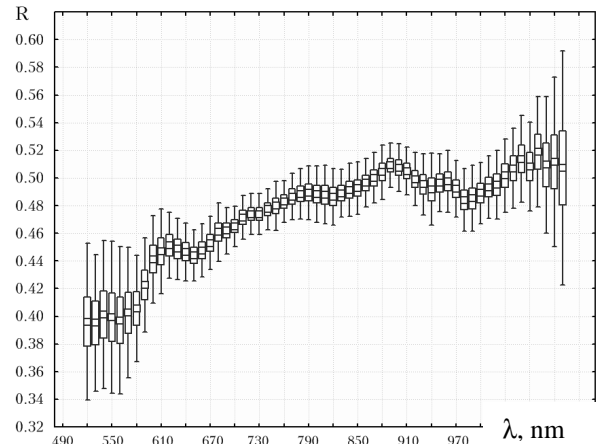

Fig. 3. Diffuse reflectance spectra of undamaged skin. Points and rectangles correspond to mean values and one standard deviation of the data, respectively.

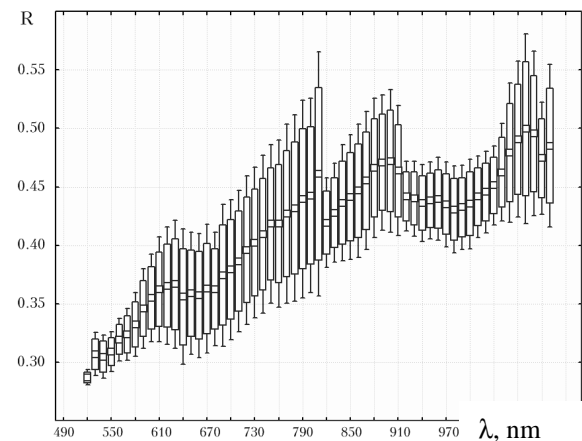

Fig. 4. The same as in Fig. 3, but for melanoma skin

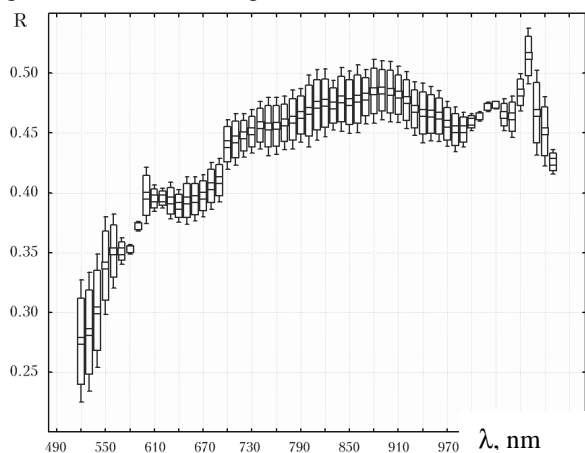

Fig. 5. The same as in Fig. 3, but for benign nevus skin

The spectra of melanoma skin (Fig. 4) show a considerably larger dispersion (up to 25 %) in the visible and near IR as compared with those of intact skin. A

healthy skin region near the melanoma one was also investigated for all these patients. The spectra of benign nevus skin (Fig. 5) show a substantially smaller dispersion (up to 5 %) in the visible and near IR as compared with those of melanoma skin. This will be shown below to enable one to differentiate nevus and melanoma skin.

Figure 6 combines the data of Figs. 3 to 5 on spectral reflectance of the considered pigment formations.

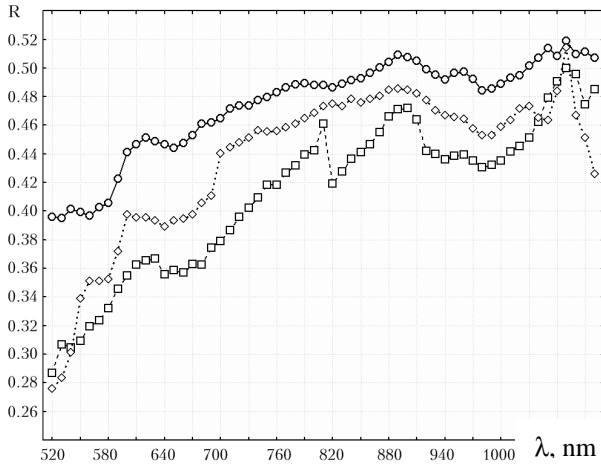

Fig. 6. Mean values of spectral reflectance of undamaged skin (\circ), melanoma (\square), and benign nevus (\diamond)

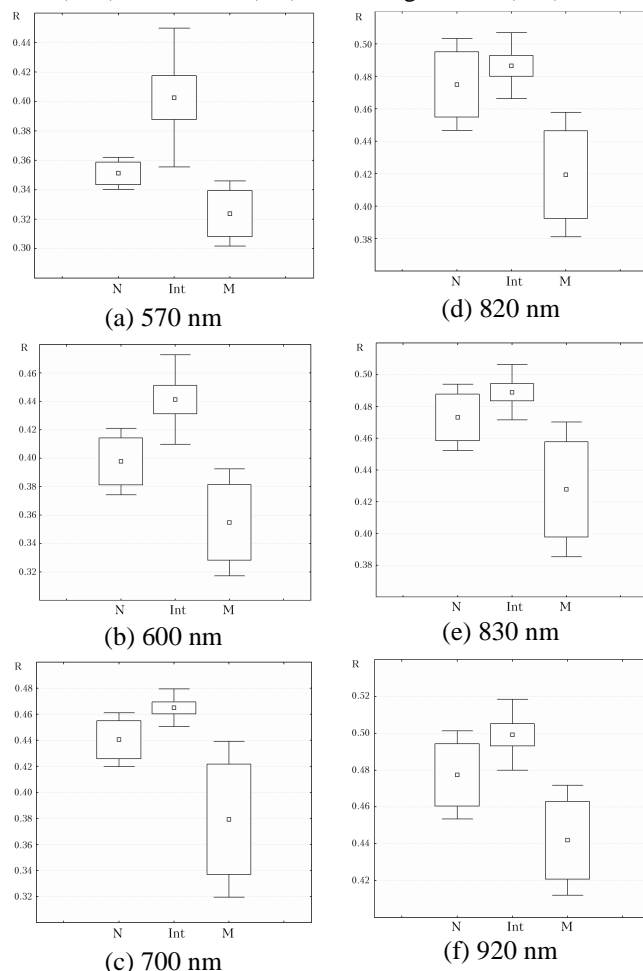

Fig. 7. Values of diffuse reflectance at several wavelengths for undamaged skin (Int), benign nevus (N) and melanoma skin (M). Points and rectangles correspond to mean values and one standard deviation of the data, respectively.

V. DISCRIMINATION OF SKIN PIGMENT FORMATIONS

The comparison of the diffuse reflectance spectra of undamaged skin (Fig. 3), skin with melanoma (Fig. 4) and benign nevus (Fig. 5) enabled a number of characteristic wavelengths to be detected, where the spectra noticeably differed. For example, such wavelengths are 570, 600, 700, 820, 830 and 900 nm (Fig. 7a – f, respectively). This provides the elaboration of some ways to discriminate melanoma skin from healthy and nevus one.

Another example of the differential diagnostics is illustrated in Fig. 8. Here wavelength 880 nm is used. Note that the abscissa is a quantity inversely proportional to the diffuse reflectance values. The ordinate is the frequency of observed reflectances for all the patients investigated or the probability density function. One can see from Fig. 8 that values $1/R > 0.5$ practically uniquely tell about melanoma. Other probability densities overlap each other. This does not enable one to make any conclusions on the discrimination between healthy skin (Int) and benign nevus (N). Note that the reflection spectra of intact skin near the melanoma region (CSM) are close to the corresponding Int and N data. In another words, this tells that optical parameters of these kinds of tissue are similar.

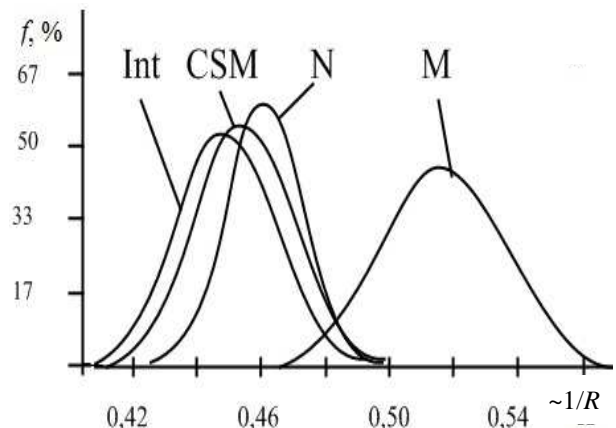

Fig. 8. Probability density of $1/R$ value for intact skin (Int), skin with melanoma (M) and benign nevus (N) at $\lambda = 880$ nm. CSM is the data for intact skin near the melanoma region

VI. CONCLUSION

Measurements of diffuse reflectance have showed that there several wavelengths in the visible and near IR, at which it is possible to discriminate melanoma from healthy and benign nevus skin. At these λ , R values for melanoma skin are lower that for other studied pigment formations. This conclusion is confirmed by the experiments to be statistically valid. Unfortunately, there are a lot of tissue structural, biophysical and optical parameters that really vary for skin pigment formations, such as epidermis thickness, melanin concentration in epidermis, blood volume fraction, blood oxygenation degree, and others. This prevents from strict theoretical simulations of skin diffuse reflectance. However, it is our future objective to use known theoretical methods for computing R spectra and comparing them with experimental results. This will enable one to propose practical methods for non-invasive optical diagnostics of melanoma cancer at its early stages.